

Name: _____

Trace the letter d in the word donut.

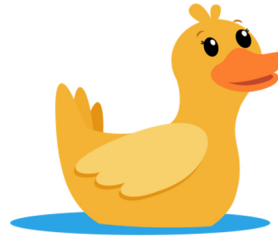

Trace the letter d in the words below.
Then find and circle them in the picture.

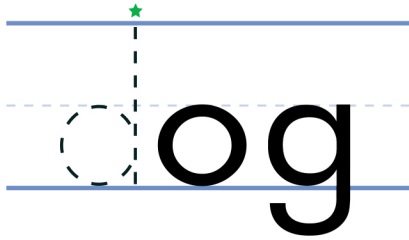

Watch and sing along to "Alphabet Train Food Train" on [YouTube](https://www.youtube.com/watch?v=...).
Visit our website for more free resources at www.mothergooseclub.com

Name: _____

Color each lowercase b in green, each lowercase d in black, and each lowercase p in blue.

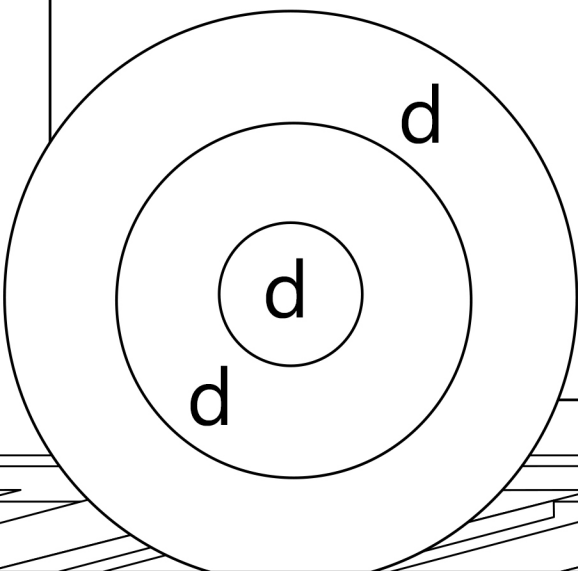
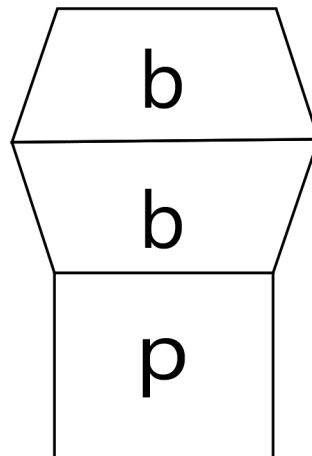
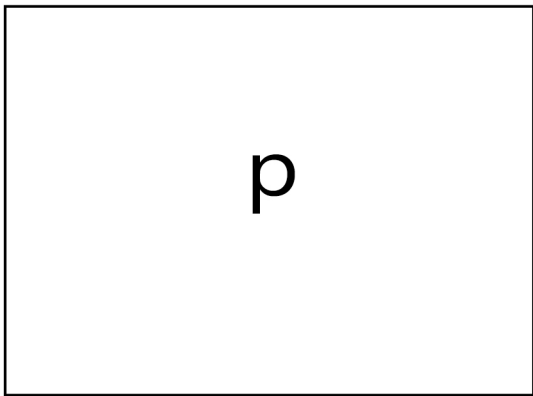
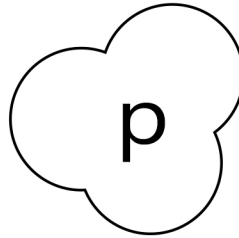
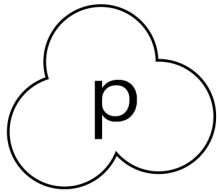
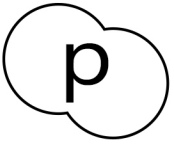

b

